



BANDPASS FILTER

FB-1450

Features

- Low Insertion Loss
- Excellent Return Loss
- High Stop Band Suppression
- Wide Stop Band
- Sharp Roll-Off
- [FB-1450.S2P](#)



Electrical Specifications – Specifications guaranteed from -55 to +100°C, measured in a 50Ω system.

Parameter	Frequency (GHz)	Min	Typ.	Max
Center Frequency, f_c (GHz)	14.50			
Passband (GHz)	11.1-17.9 ($\pm 23.5\%$ of f_c)			
Insertion Loss @ f_c (dB)				3
Passband Return Loss (dB)	11.1-17.9	15	20	
Stopband Suppression (dB)	8.6, 21.5 9.9, 19.8	40 25	50 30	
Impedance (Ω)			50	
RF Power (W)				1
Weight (g)			33	

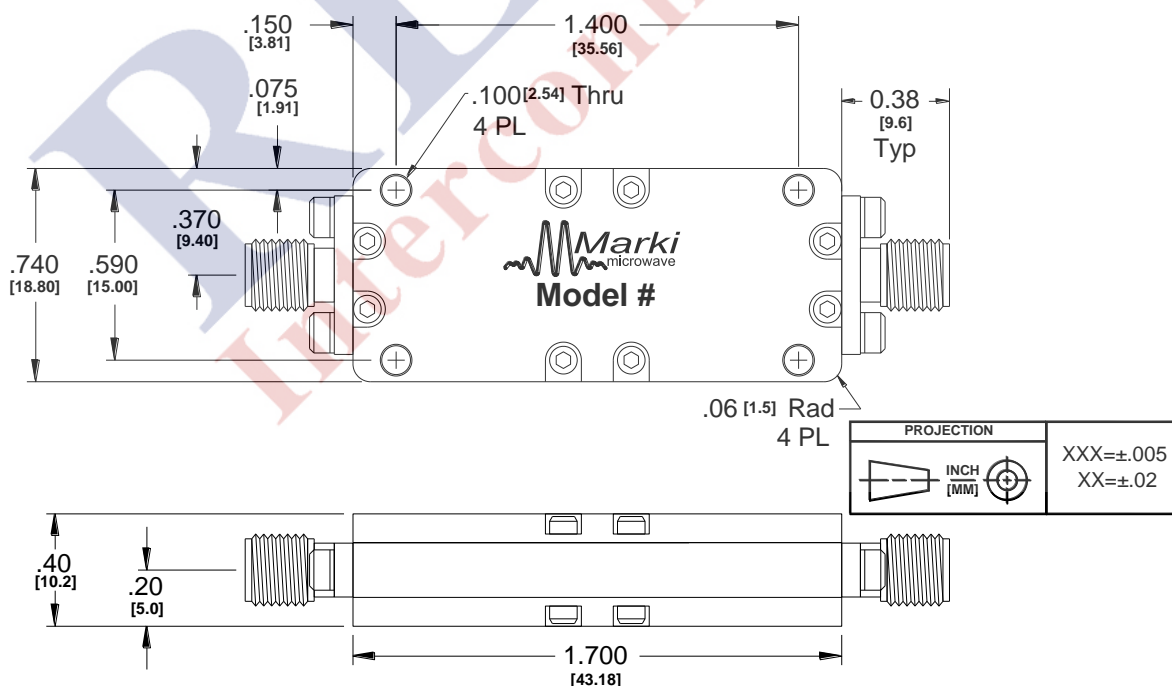

215 Vineyard Court, Morgan Hill, CA 95037 | Ph: 408.778.4200 | Fax 408.778.4300 | info@markimicrowave.com

07/11/14



BANDPASS FILTER

FB-1450

Page 2

Typical Performance

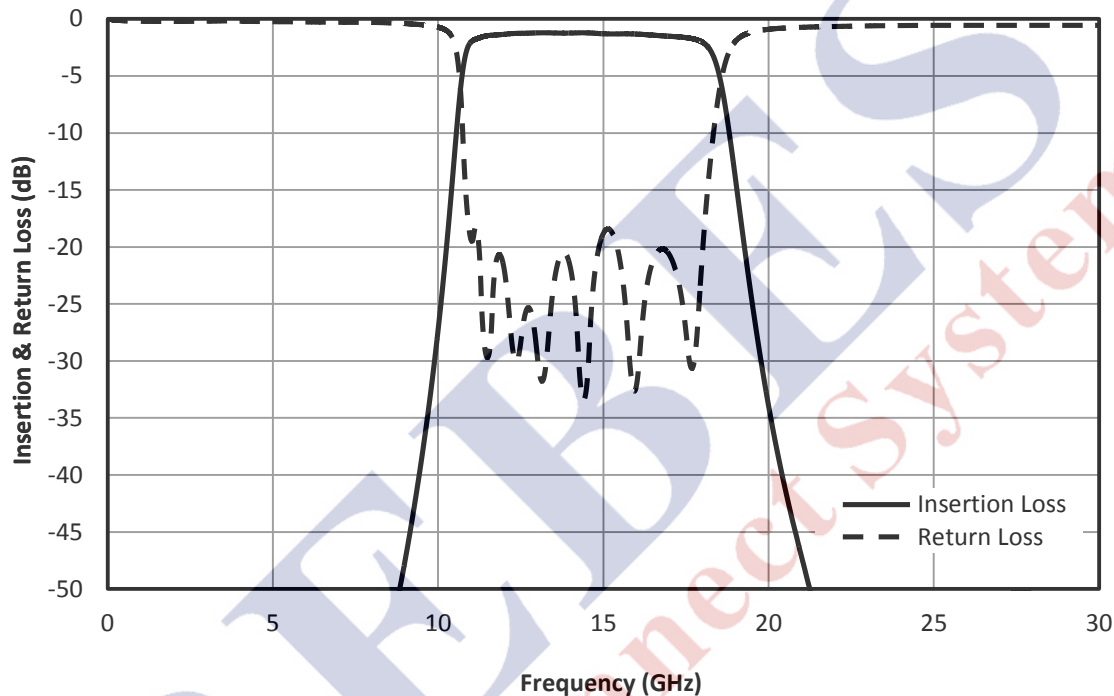

Fig. 1. Magnitude response for a typical FB-1450.

Model Number	Description
FB-1450	14.50 GHz Bandpass Filter with SMA Female connectors ¹

¹Default is SMA female connectors. Consult factory for other connector options.

NOTE:
Specifications are subject to change without notice. Contact Marki Microwave for the most recent specifications and data sheets.

Marki Microwave reserves the right to make changes to the product(s) or information contained herein without notice. Marki Microwave makes no warranty, representation or guarantee regarding the suitability of its products for any particular purpose, nor does Marki Microwave assume any liability whatsoever arising out of the use of or application of any product.

© Marki Microwave, Inc.

